













Lista de Precios 2009





 **scafom-rux**
españa









* Lista de Precios Valida, salvo error tipográfico.

	Largo m.	Ancho m.	Peso aprox. kg.	Emb. ud.	Artículo nº	Precio €/ud.
 <p>Placa base roscada Acero, galvanizado, para altas cargas. Capacidad de carga: hasta 50 kN.</p>	0,60		4,0	250	E02RS0005	
	0,78		4,8	250	E02RS0002	
 <p>Placa base roscada, giratoria Acero, galvanizado, Con placa giratoria 150 x 150 mm. Máxima carga autorizada: 25,4 kN.</p>	0,78		6,3	250	E02RS0008	
 <p>Cabeza de husillo con perfil en U Acero, 5° inclinable, placa 160 x 150 x 60 mm</p>	0,6	0,162	5,6	250	E02RS0003	
 <p>Cabeza de husillo ST52 Acero, 5° inclinable, placa 180 x 150 x 100 mm</p>	0,6	0,18	7,3	250	E02RS0013	
 <p>Pieza inicial de montante Acero</p>			1,5	250	E04RS0002	

Andamio modular RINGSCAFF						
	Largo m.	Ancho m.	Peso aprox. kg.	Emb. ud.	Artículo nº	Precio €/ud.
	Montante con empalme de tubo					
	Acero, distancia de plato 0,5 m					
	0,50		3,0	300	E04RS0005	
	1,0		5,4	150	E04RS0030	
	1,5		7,7	75	E04RS0055	
	2,0		10,0	75	E04RS0071	
	2,5		12,4	75	E04RS0225	
	Montante <u>sin empalme de tubo</u>					
	Acero, distancia de plato 0,5 m					
	0,5		2,2	300	E04RS0006	
	1,0		4,5	150	E04RS0031	
	1,5		6,8	75	E04RS0056	
	2,0		9,0	75	E04RS0072	
	2,5		11,3	75	E04RS0226	
	Montante con empalme atornillable					
	Acero, distancia de plato 0,50 m					
	0,5		3,0	300	E04RS0007	
	1,0		5,4	150	E04RS0032	
	1,5		7,7	75	E04RS0057	
	2,0		10,0	75	E04RS0073	
	2,5		12,4	75	E04RS0227	
	Montante con empalme de tubo					
	Acero, distancia de plato 0,54 m					
	1,08		6,7	150	E04RS0400	
	1,62		8,2	75	E04RS0384	
	2,16		10,4	75	E04RS0407	
	Montante <u>sin empalme de tubo</u>					
	Acero, distancia de plato 0,54 m					
	1,08			150	E04RS0694	
	1,62			75	E04RS0866	
	2,16			75	E04RS0725	

	Largo m.	Ancho m.	Peso aprox. kg.	Emb. ud.	Artículo nº	Precio €/ud.
 <p>Horizontal Acero</p>	0,25		1,4	300	E04RS0504	
	0,39		1,9		E04RS0505	
	0,667		2,9	300	E04RS0483	
	0,73		3,0	300	E04RS0011	
	0,75		3,0	300	E04RS0110	
	1,00		4,0		E04RS0324	
	1,065		4,3	200	E04RS0221	
	1,09		4,4	200	E04RS0033	
	1,29			200	E04RS0042	
	1,40		5,5	200	E04RS0047	
	1,50		5,8	150	E04RS0121	
	1,57		6,1	150	E04RS0058	
	2,00		7,6	150	E04RS0122	
	2,07		7,9	150	E04RS0074	
	2,50		9,4	150	E04RS0123	
	2,57		9,6	150	E04RS0086	
3,00		11,2	150	E04RS0124		
3,07		11,4	150	E04RS0099		
 <p>Horizontal, reforzada Acero</p>	1,09		5,9	60	E04RS0228	
	1,29		7,0	60	E04RS0229	
	1,40		8,3		E04RS0415	
	1,5		8,9		E04RS0266	
	1,57				E04RS0267	
	2,57				E04RS0230	
	3,00				E04RS0414	
	3,07				E04RS0416	
 <p>Horizontal, reforzada Acero. Perfil - T</p>	1,00				E04RS0488	
	1,088				E04RS0651	
	1,40				E04RS0653	
	1,50				E04RS0654	
	1,572				E04RS0655	
	2,00				E04RS0584	
	2,072				E04RS0656	
	2,50				E04RS0585	
	2,572				E04RS0657	
	3,00				E04RS0658	
3,07				E04RS0659		
 <p>Horizontal, doble Acero</p>	1,40		9,1	60	E04RS0231	
	1,50		9,6	60	E04RS0144	
	1,57		10,1	60	E04RS0232	
	2,00		12,3	60	E04RS0145	
	2,07		12,7	60	E04RS0233	
	2,50		15,4	60	E04RS0268	
	2,57		15,8	60	E04RS0234	
	3,00		18,0	60	E04RS0269	
	3,07		18,4	60	E04RS0235	

	Largo m.	Ancho m.	Peso aprox. kg.	Emb. ud.	Artículo nº	Precio €/ud.	
	Horizontal intermedia						
	Acero						
	0,667				E04RS0482		
	0,73		3,6	150	E04RS0020		
	0,75			150	E04RS0649		
	1,00				E04RS0535		
	1,065		5,1	150	E04RS0249		
	1,09		5,3	150	E04RS0039		
	1,40		6,4	150	E04RS0053		
	1,50		7,1	150	E04RS0250		
	1,57		7,2	150	E04RS0067		
	2,00		8,1	150	E04RS0251		
	2,07		8,3	150	E04RS0202		
	2,50		10,0	150	E04RS0252		
2,57		10,1	150	E04RS0236			
3,00		12,0	150	E04RS0253			
3,07		12,1	150	E04RS0237			
	Horizontal con perfil en U						
	Acero						
0,45				300			
0,73		3,4		300	E04RS0378		
	Horizontal Reforzada, perfil U						
	Acero						
1,088		6,2		100	E04RS0379		
1,40				100	E04RS0380		
	Horizontal doble, perfil en U						
	Acero						
	1,57		10,1		60	E04RS0392	
	2,07		12,7		60	E04RS0395	
2,57		15,8		60	E04RS0397		
3,07		18,4		60	E04RS0399		
	Horizontal intermedia con alargamiento 2-3 Tablas						
	Acero						
	1,09 / 0,48 / 0,21		10,4		E04RS0550		
	Alcance de ajuste: 410 mm	1,40 / 0,48 / 0,21			E04RS0353		
Alcance de ajuste: 600 mm							
1,40				E04RS0607			
1,57				E04RS0618			
Horizontal Telescopica con Junta							
1190				E04AA0117			
1300				E04AA0120			
1400				E04AA0113			
1570				E04AA0118			

	Largo m.	Ancho m.	Peso aprox. kg.	Emb. ud.	Artículo nº	Precio €/ud.
	0,30	1 tabla	4,4	50	E04RS0371	
	0,62	2 tablas	5,5	50	E04RS0372	
	0,33	1 tabla	2,8	50	E04RS0363	
	0,65	2 tablas	4,1	50	E04RS0364	
	0,80				E04RS0413	
	0,32	1 tabla			E04RS0547	
	0,64	2 tablas			E04RS0548	
	0,32	1 tabla			E04RS0544	
	0,64	2 tablas			E04RS0545	
	0,30	1 tabla	4,4	50	E04PF0021	
	0,62	2 tablas	5,5	50	E04PF0022	
	0,33	1 tabla	2,8	50	E04PF0023	
	0,65	2 tablas	4,1	50	E04PF0024	
					E04RS0617	

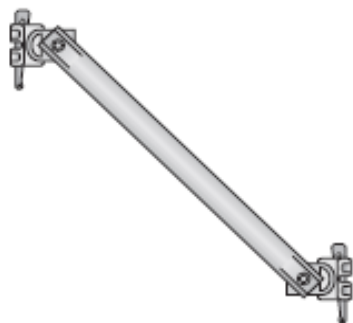





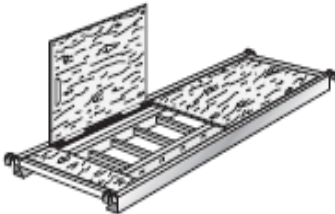
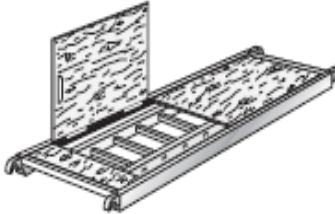
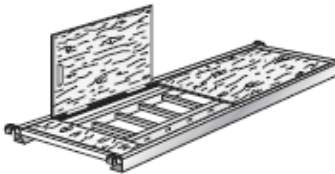

Andamio modular RINGSCAFF						
	Largo m.	Ancho m.	Peso aprox. kg.	Emb. ud.	Artículo nº	Precio €/ud.
Diagonal Acero	0,73	2,00	7,2	150	E04RS0017	
	0,75	2,00	7,3	150	E04RS0213	
	1,065	2,00	7,5	150	E04RS0220	
	1,09	2,00	7,5	150	E04RS0038	
	1,40	2,00	7,9	150	E04RS0051	
	1,50	2,00	8,0	150	E04RS0131	
	1,57	2,00	8,1	150	E04RS0065	
	2,00	2,00	8,9	150	E04RS0134	
	2,07	2,00	9,0	150	E04RS0077	
	2,50	2,00	9,9	150	E04RS0133	
	2,57	2,00	10,0	150	E04RS0092	
	3,00	2,00	11,0	150	E04RS0135	
	3,07	2,00	11,0	150	E04RS0102	
	0,73	1,50		150	E04RS0319	
	1,09	1,50	6,8	150	E04RS0334	
	1,40	1,50	7,2	150	E04RS0320	
	1,50	1,50	7,5	150	E04RS0323	
	1,57	1,50	7,6	150	E04RS0335	
	2,00	1,50	8,0	150	E04RS0276	
	2,07	1,50	8,2	150	E04RS0336	
	2,50	1,50	9,3	150	E04RS0322	
	2,57	1,50	9,6	150	E04RS0337	
	3,00	1,50	10,3	150	E04RS0316	
	3,07	1,50	10,5	150	E04RS0338	
	1,09	1,00	4,9	150	E04RS0328	
	1,40	1,00	5,5	150	E04RS0329	
	1,50	1,00	5,7	150	E04RS0287	
	1,57	1,00	5,9	150	E04RS0330	
	2,00	1,00	6,9	150	E04RS0286	
	2,07	1,00	7,1	150	E04RS0331	
	2,50	1,00	8,0	150	E04RS0285	
	2,57	1,00	8,2	150	E04RS0332	
	3,00	1,00	9,6	150	E04RS0315	
3,07	1,00	9,8	150	E04RS0333		
1,088	2,16	7,5	150	E04RS0404		
1,40	2,16	8,1	150	E04RS0402		
1,57	2,16	8,4	150	E04RS0403		
2,07	2,16	9,1	150	E04RS0405		
2,57	2,16	10,0	150	E04RS0401		
3,07	2,16	12,8	150	E04RS0406		
2,57	2,70			E04RS0693		

	Largo m.	Ancho m.	Peso aprox. kg.	Emb. ud.	Artículo nº	Precio €/ud.
 <p>Diagonal Horizontal Acero</p>	1,065	1,065	4,2		E04RS0518	
	1,50	1,065	5,1		E04RS0519	
	2,00	1,065	6,2		E04RS0520	
	2,07	0,73	6,4		E04RS0194	
	2,57	0,73	7,6		E04RS0198	
 <p>Plataforma de Acero Apoyo de tubo</p>	0,73	0,32	8,0	60/45	E04RS0021	
	1,09	0,32	10,4	60/45	E04RS0040	
	1,40	0,32	12,2	60/45	E04RS0273	
	1,57	0,32	13,6	60/45	E04RS0063	
	2,07	0,32	17,2	60/45	E04RS0075	
	2,57	0,32	20,5	60/45	E04RS0090	
	3,07	0,32	23,8	60/45	E04RS0100	
 <p>Plataforma de Acero Apoyo de tubo</p>	0,73	0,19	4,8	60/45	E04RS0419	
	1,09	0,19	7,2	60/45	E04RS0420	
	1,40	0,19	9,2	60/45	E04RS0421	
	1,57	0,19	10,3	60/45	E04RS0422	
	2,07	0,19	13,6	60/45	E04RS0423	
	2,57	0,19	16,9	60/45	E04RS0424	
	3,07	0,19	20,2	60/45	E04RS0425	
 <p>Plataforma de Acero Apoyo en U</p>	0,73	0,32	8,0	60/45	E04RS0433	
	1,09	0,32	10,4	60/45	E04RS0435	
	1,40	0,32	12,2	60/45	E04RS0436	
	1,57	0,32	13,6	60/45	E04RS0438	
	2,07	0,32	17,2	60/45	E04RS0441	
	2,57	0,32	20,5	60/45	E04RS0443	
	3,07	0,32	23,8	60/45	E04RS0445	
 <p>Plataforma de Acero Apoyo en U</p>	0,73	0,19	4,8	60/45	E04RS0608	
	1,09	0,19	7,2	60/45	E04RS0609	
	1,40	0,19	9,2	60/45	E04RS0610	
	1,57	0,19	10,3	60/45	E04RS0611	
	2,07	0,19	13,6	60/45	E04RS0612	
	2,57	0,19	16,9	60/45	E04RS0613	
	3,07	0,19	20,2	60/45	E04RS0614	

Andamio modular RINGSCAFF



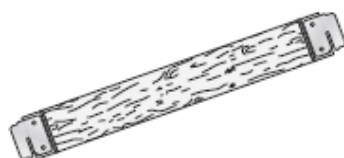

	Largo m.	Ancho m.	Peso aprox. kg.	Emb. ud.	Artículo nº	Precio €/ud.
 <p>Plataforma de acero 0,32 m para apoyo de tubos con garras de apoyo estampadas</p>	0,75	0,32	8,0	60/45	E04PF0009	
	1,00	0,32	8,3	60/45	E04PF0017	
	1,065	0,32	10,2	60/45	E04PF0001	
	1,40	0,32	12,2	60/45	E04PF0010	
	1,50	0,32	13,0	60/45	E04PF0002	
	2,00	0,32	16,6	60/45	E04PF0003	
	2,50	0,32	19,9	60/45	E04PF0004	
	3,00	0,32	23,3	60/45	E04PF0005	
 <p>Plataforma de acero 0,14 m para apoyo de tubos</p>	1,065	0,14			E04PF0015	
	1,50	0,14			E04PF0016	
	2,00	0,14			E04PF0006	
	2,50	0,14			E04PF0007	
	3,00	0,14			E04PF0008	
 <p>Plataforma de acero fuera de sistema antideslizante</p>	1,00	0,30	6,9	80	E04AA0241	
	1,50	0,30	9,3	80	E04AA0242	
	2,00	0,30	11,7	80	E04AA0243	
	2,50	0,30	14,1	80	E04AA0244	
	1,00	0,26	6,7	80	E04AA0175	
	1,50	0,26	9,1	80	E04AA0235	
	2,00	0,26	11,4	80	E04AA0236	
	2,50	0,26	13,6	80	E04AA0240	
Clip para plataforma fuera de sistema					E04AA0237	
 <p>Fiador plataforma de acero para soporte U</p>	0,73		1,3		E04RS0594	
	1,09		1,8		E04RS0595	
	1,40		2,5		E04RS0596	
	1,57		3,0		E04RS0597	
	2,07		7,5		E04RS0598	
	2,57		8,9		E04RS0599	
	3,07		11,9		E04RS0600	

	Largo m.	Ancho m.	Peso aprox. kg.	Emb. ud.	Artículo nº	Precio €/ud.
 <p>Trampilla de aluminio con escalera integrada para soporte U, con tablero contrachapado con serigrafía y resistente al agua</p>	2,57	0,61	21,0	10	E04RS0467	
	3,07	0,61	24,5	10	E04RS0468	
 <p>Trampilla de aluminio con escalera integrada para apoyo de tubo, con tablero contrachapado con serigrafía y resistente al agua</p>	2,07	0,61			E04RS0896	
	2,57	0,61	21,0	10	E04RS0465	
	3,07	0,61	24,5	10	E04RS0466	
 <p>Trampilla de aluminio con escalera integrada para apoyo de tubo, con tablero contrachapado con serigrafía y resistente al agua</p>	2,50	0,64		10	E04PF0044	
	3,00	0,64		10	E04PF0045	
	2,50	0,60		10	E04PF0018	
	3,00	0,60		10	E04PF0019	
 <p>Plataforma de acero (derecho) apoyo de tubo 0,06</p>	2,57	0,32			E04RS0915	
	2,57	0,64			E04RS0916	
	2,57	0,96			E04RS0917	
	3,07	0,32			E04RS0918	
	3,07	0,64			E04RS0919	
	3,07	0,96			E04RS0920	
 <p>Plataforma de acero (izquierda) apoyo de tubo 0,06</p>	2,57	0,32			E04RS0922	
	2,57	0,64			E04RS0923	
	2,57	0,96			E04RS0924	
	3,07	0,32			E04RS0925	
	3,07	0,64			E04RS0926	
	3,07	0,96			E04RS0927	
	 <p>Ayuda de pie inclinado (para piso)</p>		2			E04RS0921
 <p>Panel de esquina 0,39m (para tubo)</p>					E04RS0690	
 <p>Panel de esquina 0,73m (para tubo)</p>					E04RS0687	





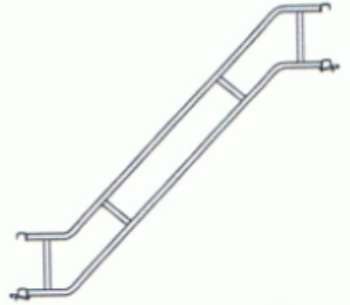
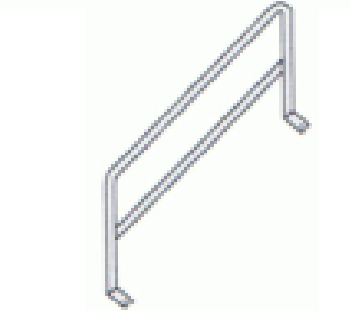

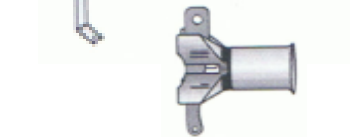



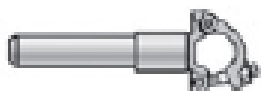
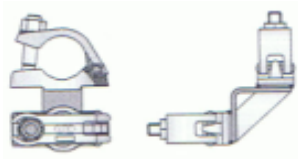

Andamio modular RINGSCAFF						
	Largo m.	Ancho m.	Peso aprox. kg.	Emb. ud.	Artículo nº	Precio €/ud.
Escalera Ringscaff	1,00				E04RS0500	
	2,00				E04RS0454	
	3,00				E04RS0455	
	4,00				E04RS0456	
Rodapié, madera	0,667	0,667	2,5	100	E04RS0487	
	0,73	0,73	2,8	100	E04RS0016	
	0,75	0,75	2,9	100	E04RS0517	
	1,00	1,00	3,4	100	E04RS0503	
	1,065	1,065	3,8	100	E04RS0254	
	1,09	1,09	3,9	100	E04RS0037	
	1,40	1,40	4,9	100	E04RS0054	
	1,50	1,50	5,3	100	E04RS0255	
	1,57	1,57	5,5	100	E04RS0064	
	2,00	2,00	7,0	100	E04RS0256	
	2,07	2,07	7,2	100	E04RS0076	
	2,50	2,50	8,6	100	E04RS0257	
	2,57	2,57	8,8	100	E04RS0091	
	3,00	3,00	10,1	100	E04RS0258	
3,07	3,07	10,3	100	E04RS0101		
Pieza cabecera para rodapie			0,4		E04RS0284	
Rodapié, acero	0,67	0,67	2,3	100	E04RS0660	
	0,73	0,73	2,4	100	E04RS0631	
	1,00	1,00	3,3	100	E04RS0644	
	1,065	1,065	3,2	100	E04RS0661	
	1,09	1,09	3,4	100	E04RS0632	
	1,50	1,50	4,5	100	E04RS0645	
	1,57	1,57	4,7	100	E04RS0634	
	2,00	2,00	5,9	100	E04RS0646	
	2,07	2,07	6,1	100	E04RS0635	
	2,50	2,50	7,3	100	E04RS0647	
	2,57	2,57	7,5	100	E04RS0636	
	3,00	3,00	8,6	100	E04RS0648	
	3,07	3,07	8,7	100	E04RS0637	
	3,00	3,00	10,1	100	E04RS0648	
3,07	3,07	10,3	100	E04RS0637		

Andamio modular RINGSCAFF

	Largo m.	Ancho m.	Peso aprox. kg.	Emb. ud.	Artículo nº	Precio €/ud.
 <p>Escalera de aluminio con descansillo (tubo)</p> <p>Anchura de escalera : 0,80 m Anchura de escalón : 0,72 m Distancia de escalón : 0,22 m Altura de piso : 2,00 m</p> <p>Carga admisible 3,50 kN/m2</p>	2,00	2,572	31,0	1	E04RS0571	
	2,16	2,572	32,5	1	E04RS0679	
 <p>Escalera de aluminio con descansillo (U)</p>	2,00	2,572	30,4		E04RS0589	
 <p>Pasamanos exterior de escalera</p>	2,00	2,572	13,8	1	E04RS0572	
	2,16	2,572	16,9	1	E04RS0682	
 <p>Pasamanos interior de escalera</p>	2,00	2,572 3,07	10,9	1	E04RS0573	
	2,16	2,572 3,07	11,8	1	E04RS0684	
 <p>Pasamanos interior Extendido</p>	2,00	2,572 3,07	13,7	1	E04RS0593	
	2,16	2,572 3,07	14,3	1	E04RS0685	
 <p>Adaptador Soporte de pasamanos</p>			0,75		E04RS0592	

	Largo m.	Ancho m.	Peso aprox. kg.	Emb. ud.	Artículo nº	Precio €/ud.
						
 Puntal de escalera	2,00 2,00	2,50 2,57	16,8 17,0		E04RS0537 E04RS0205	
 Elemento de cabecera de escalera (izquierda)	2,00	2,50 2,57	1,1		E04RS0496	
 Elemento de cabecera de escalera (derecha)	2,00	2,50 2,57	1,1		E04RS0495	
 Pisa de escalera		1,25 1,286	7,8		E04RS0540 E04RS0494	
 Cónsola de acero Para apoyo de tubo		0,39 0,73 1,09	3,8 6,8 11,5	50 50 50	E04RS0543 E04RS0018 E04RS0270	
 Cónsola de acero Para apoyo en 'U'		0,39 0,73	3,8 6,8	50 50	E04RS0449 E04RS0417	
 Cónsola ajustable Para apoyo de tubo		0,48/0,21 0,48/0,30 0,70/0,30	4,1 4,2 6,5		E04RS0549 E04RS0605 E04RS0650	

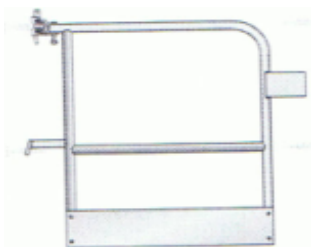
	Largo m.	Ancho m.	Peso aprox. kg.	Emb. ud.	Artículo nº	Precio €/ud.
						
Cercha de aluminio	3,20	0,45	13,0	10	E04AA0053	
Tubo de aluminio, 48,3 mm Ø,	4,20	0,45	17,0	10	E04AA0054	
espesor de pared 4 mm	5,20	0,45	21,0	10	E04AA0055	
	6,20	0,45	25,0	10	E04AA0056	
	8,20	0,45	33,0	10	E04AA0058	
					E04AA0107	
Empalme para cercha (aluminio)						
						
Cercha de acero galvanizado	3,20	0,45	30,0	10	E04AA0097	
Tubo de acero St 37-2, 48,3 mm Ø,	4,20	0,45	37,0	10	E04AA0098	
espesor de pared 3,25 mm	5,20	0,45	48,0	10	E04AA0099	
	6,20	0,45	61,0	10	E04AA0100	
	8,20	0,45	75,0	10	E04AA0102	
					E04AA0044	
Empalme para cercha (acero)						
						
Cercha + empalme de tubo	4,14	0,45	43,3		E04RS0240	
	5,14	0,45	52,6		E04RS0241	
	6,14	0,45	62,8		E04RS0242	
	7,71	0,45	79,3		E04RS0259	
					E04RS0003	
Empalme de tubo-semi-grapa Acero, galvanizado	SW22		1,25			
					E04RS0559	
Viga grapa			1,6			

	Largo m.	Ancho m.	Peso aprox. kg.	Emb. ud.	Articulo nº	Precio €/ud.
	Tubo de anclaje	0,35			E04AA0005	
		0,90			E04AA0006	
		1,00			E04AA0004	
		1,50			E04AA0007	
		1,60			E04AA0029	
		1,80			E04AA0039	
		2,00			E04AA0030	
		2,40			E04AA0046	
	Tubo de anclaje Curvado	0,40			E04AA0025	
		0,60			E04AA0026	
		0,80			E04AA0027	
		1,00			E04AA0095	
		1,20			E04AA0155	
		1,50			E04AA0156	
	Mastil de Pasamanos	1,70		8,7	E04RS0501	
	Puerta de seguridad N°4 con rodapié			10,2	E04RS0533	
	Travesaño de proteccion con rodapié			13,7	E04RS0373	

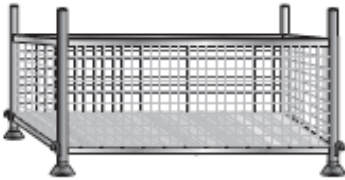
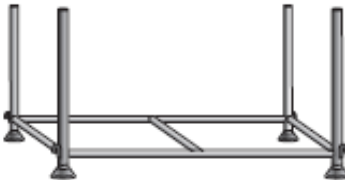
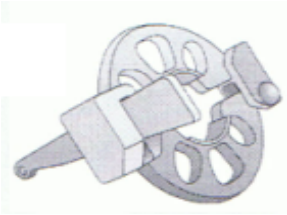
	Largo m.	Ancho m.	Peso aprox. kg.	Emb. ud.	Articulo nº	Precio €/ud.
 <p>Jaula para accesorios</p>	0,85	1,25	89,74		E08SR0028	
 <p>Batidor Ringscaff</p>	0,85	1,25	46		E08SR0012	
 <p>Roseta acopladora para barrera de seguridad</p>					E0RS0224	
<p>Grapa de cuñas P21 en 74 Normal</p>				500	E04AA0036	
<p>Grapa de cuñas P22 en 74 Giratoria</p>				600	E04AA0037	
<p>EN74 Grapa de foja Normal 48/48 SW 22</p>				600	E04AA0037	
<p>Tornillo de acoplamiento 48,3 EN74 SW19 CLASE B-B</p>					E04AA0121	